

# Lighting Cam

SL1001

User's Manual

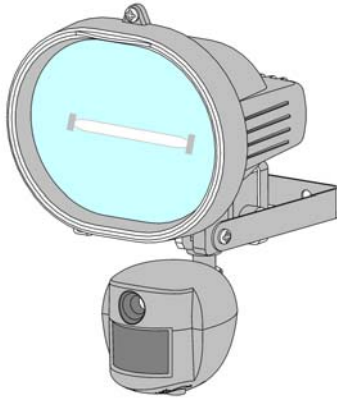

Version 0.3

Sept 07

## Manual Contents:

A. Camera kit contents	3
B. SL1001 overview	4
C. Definition	6
D. Mounting the camera	13
E. Camera setup – Getting started	14
F. Setting the MODE of your SL1001	22
G. Driver and Ulead Photo Explorer installation	27
H. Viewing images via PC or digital camera	28
I. Web Cam Mode	30
J. Technical Specifications	32
K. General information and safety	35
L. FCC information	37

2

### A. Camera kit contents

- Model SL1001 Lighting Camera
- USB Cable
- Camera driver CD
- User Manual

### B. SL1001 overview

#### 1. Front view

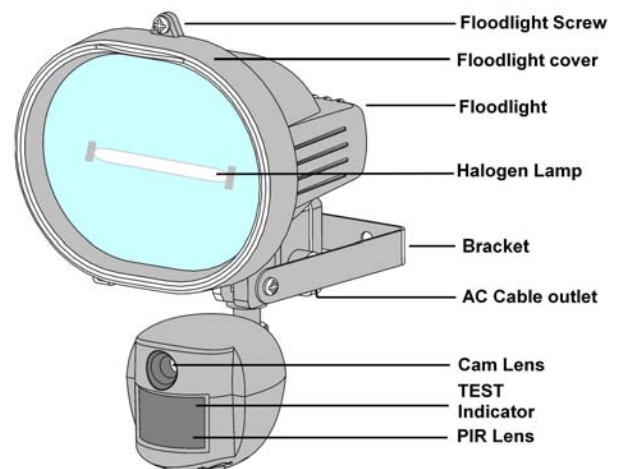

3

4

## 2. Base view

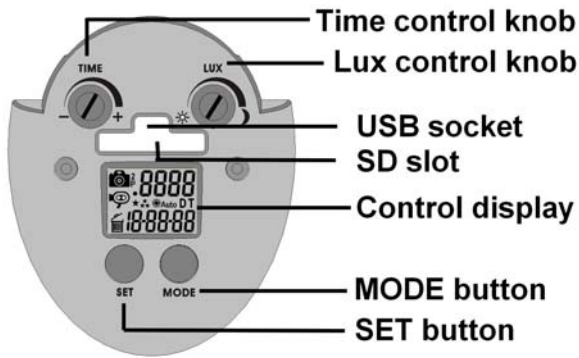

5

## C. Definitions

### 1. Definitions of Front view parts.

- Flood light screw: Used to open or close the flood light case to replace the halogen lamp.
- Flood light cover: Open to replace lamp
- Floodlight:
- Halogen lamp: For lighting purpose, please use the correct voltage and wattage of halogen light for this product. Halogen lamp R7S, Max power: 500W.
- Bracket: For mounting the SL1001.
- AC cable outlet: For connecting the external AC cable to SL1001.
- Cam Lens: This is the digital camera lens. Use a soft cloth to clear if necessary,
- PIR lens: Passive Infrared movement sensor.
- TEST Indicator: A red indicator behind the PIR lens which lights when testing the PIR coverage area and flashes during the arming count down time.

6

### 2. Definition of Base view parts.

- Time control knob: For adjusting the time that the halogen floodlight will stay on for.
- Lux control knob: For adjusting the ambient lighting level at which the floodlight will come on automatically.
- USB socket: For connecting the SL1001 to a PC with the USB lead provided.
- SD slot: For inserting a SD memory card. Ensure card is unlocked and it firmly pushed in. Press again to release and remove.
- Control display: Icon display showing settings. Refer to later in this manual for details.
- SET button: To adjust the settings on your SL1001.
- MODE button: To change the mode of your SL1001.





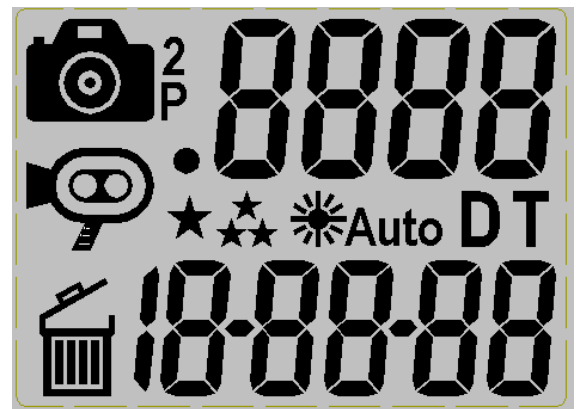

7





### 3. Definition of Control display.



- : Still image capture icon. Indicates your SL1001 will capture a single image.

8

- : 2 Photos burst capture icon. Indicates your SL1001 will capture two consecutive images.
- : Image counter to show how many images or videos have been captured.
- : Storage status icon. Only present if an external SD card installed. If no icon your SL1001 will use its internal built memory.
- : Video-capturing icon. Indicates your SL1001 is in video capturing mode and will capture 10 second video bursts.
- : High-resolution icon. Indicates the SL1001 is in high-resolution still image capturing mode.
- : Low-resolution icon. Indicates the SL1001 is in low-resolution still image capturing mode.

- **D**: Date setting mode. Indicates when your SL1001 is in Date setting mode.
- **T**: Time setting mode. Indicates when your SL1001 is in Time setting mode.
- : Rubbish bin icon, Indicates the SL1001 is in delete mode.
-  **Auto**: Floodlight control icon,  
When showing, the floodlight will turn on if the camera sensor detects the light levels are too low.  
When the Icon is not showing the floodlight is turned on when the photo sensor detects the light level has dropped below the threshold set with the LUX control.
- : Shows the Date and time.
- : Pressing the SET button will exit the current mode.

#### 4. Picture / Image Capacity

SD card	High 2.0M 1600x1200	Low 1.3M 1280x1024	AVI QVGA 320x240
Built In memory	8	12	2
16MB	26	40	8
32MB	52	80	16
64MB	104	160	32
128MB	208	320	64
256MB	416	640	128
512MB	832	1280	256
1GB	1664	2560	512

**NOTE:** Picture / Image Capacity Chart shows the approximate number of images or video clips that can be stored based on the resolution setting and the size of memory card. These figures may vary depending on the amount of detail in the image. Also, when your memory card is full, your SL1001 will begin overwriting the earliest data ensuring you always have the most recent images.

#### Memory Options – Up to 1Gb SD card

Your SL1001 lighting camera is equipped with 16MB built in SDRAM memory. Please note:- data stored on internal memory may be lost in the event of a power failure. We therefore recommend the use of external memory using the media card slot capable of accepting up to 1GB SD card (sold separately). With no memory card inserted into the slot, the camera will use the built in 16MB SDRAM memory. If a SD card is inserted into the slot then the camera will bypass the built in memory and write to the SD memory. It is not recommended that a card is inserted or removed during operation as this can cause malfunction. The counter display will show the number of images on the built in memory and will change to show the number on a memory card if one is fitted.

## D. Mounting the camera

Mount the SL1001 to a solid surface more than ½" or 12.7mm thick in a secure location overseeing the area to monitor. We suggest you mount the camera between 2 meters off the ground with the camera pointing at a downward angle 15 degrees. Be sure to avoid mounting the camera facing east or west as the rising and setting of the sun may produce false triggers and overexposed images.

Ensure the front of your SL1001 is clear of any branches and other debris so your camera view or PIR sensor are not obscured.

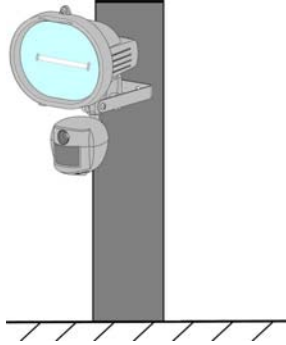

13

## E. Camera setup – getting started

### 1. Inserting SD card

❖ **SD cards must not contain any other images and you must ensure your SL1001 is disconnected to AC power when adding or removing an SD memory card. Failure to observe these rules may result in malfunction.**

- Insert the SD memory card in to the SD card slot completely and in the correct direction as shown on the inside of the housing.

- **DO NOT FORCE THE SD CARD**

- To remove the SD memory card, push the SD card in and it will spring out, now pull out the card gently.

### 2. Connect the SL1001 to AC power. (See section L)

❖ **Please make sure your SL1001 is rated for your voltage before connection. Incorrect voltage will damage the camera.**



14

**IMPORTANT** - Observe correct wiring as shown below  
Failure to do so may result in damage to your unit  
and will void your warranty.

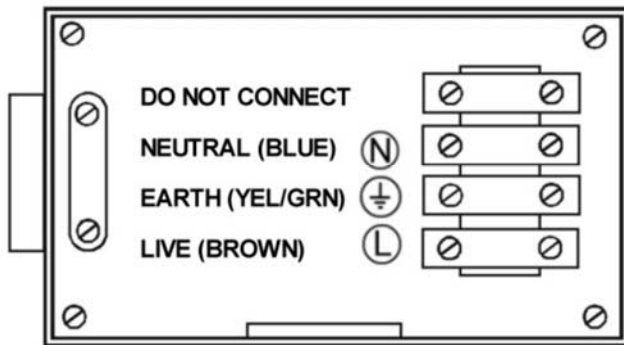

(Wiring applies from Sept 07 - earlier models may vary.)

Please consult correct manual for product )

15

- Ensure you connect your SL1001 in accordance with the wiring diagram. Failure to do so may result in damage to your SL1001 and will void your warranty.
- We recommend using a supply that you can switch off if required. Once wired correctly, turn on the mains supply.
- When connected the SL1001 lamp will turn on for approximately 60 seconds whilst self-testing. It is then ready for operation and will begin recording images each time the motion sensor is triggered.

### Replacing the halogen lamp if faulty

**CAUTION your lamp will be very hot.**

- Always disconnect the power to your SL1001 before opening.
- Release the floodlight screw to open the floodlight cover.
- Carefully remove the Halogen lamp – it may be HOT.
- Insert a new Halogen lamp making sure you do not touch the lamp with bare skin. Halogen Lamp : Max 500W R7S
- Close the floodlight cover and screw together carefully.

16

## Settings.

You can change the settings on your SL1001. The parameters that can be changed and the default values are shown below. Please note after changing any settings the test LED will flash and the unit will count down for approx. 60 seconds before arming.

Setting	Default	
Time	00:00	HH:MM
Date	04:01:06	MM:DD:YY
Flicker frequency	50 Hz	50 / 60
Image capture interval	1 minute	0-60
Resolution	High	High/Low
Image capture method	Video	Video/Photo
Floodlight control	Off	On/Off

Your SL1001 can be used straight away but before use you may wish to change some or all of the settings – see the next sections.

17

## 3. Set the Data and Time.

- After mounting your SL1001 (with SD card already fitted if required) connect the camera to the AC power. The camera will turn on automatically and will begin to count down ready to arm.

- Press the SET and MODE button together once to enter TEST MODE, the LCD will display the word

“ t E S t ”.

- Press the MODE button repeatedly until the LCD displays: “ T, 00-00 “ and are flashing.



- Press the SET button repeatedly to set the HOURS
- Press the MODE button to confirm.
- Now press the SET button repeatedly to set the MINUTES, then press the MODE button to confirm.

18

- The display will now change to “4.01.06” representing the date in the format MM.DD.YY
- Press the SET button to set the MONTH followed by the MODE button to confirm.
- Repeat this process to set the Day and Year.
- Still images will be stamped with the time and date you set here.
- ❖ **NOTE: Settings and images stored on internal memory may be lost in the event of a power failure. Always ensure you reset your SL1001 following a loss of power.**

## 4. Setting the flicker frequency 60Hz or 50Hz

By adjusting your SL1001 to reflect the AC power frequency you will eliminate any flicker effect on captured images.

For the UK this must be set to 50Hz.

- When SL1001 is in TEST MODE, press the MODE button repeatedly until the LCD flashes “ 60HZ ”

19



- Now press MODE button to change to 50Hz (UK)
- Press the SET button to confirm your choice. The LCD will display “ dONE “ and then display “ ESC “
- Press the SET button again to exit and return to TEST MODE.
- Press the MODE and SET button together again to leave the TEST MODE.

## 5. Testing the sensor coverage area

In test mode the SL1001 allows you to test the coverage area.

- After mounting connect your camera to AC power, the camera will turn on automatically.
- It will now start to count down to arm – approx 60 seconds.

20

- Pressing the SET and MODE button together to enter TEST MODE, the LCD will display the word “ t E S t ”.
- Whilst in test mode, each time the PIR sensor is triggered a red indicator behind the PIR lens will flash to indicate a trigger. Walk around the coverage area to determine if your camera is suitably mounted.
- Adjust the position of your SL1001 if necessary and repeat testing until the desired coverage area is achieved.
- When you have completed the coverage area testing, press the MODE and SET button together again to leave the TEST MODE.
- The SL1001 will start a 60 seconds count down again.
- Alternatively, when you have finished testing if you leave the SL1001 for approximately 5 minutes it will automatically begin the 60 seconds count down.
- Please leave the coverage area within 60 seconds to avoid being photographed or videoed.

21

## F. Setting the MODE for your SL1001

Press and hold the MODE button until the camera ICON begins to flash.

- Image capture interval setting:** This determines the delay between successive image capture. When set, the SL1001 will take a picture when triggered and then wait for the set delay before taking another image even if triggered in that time.

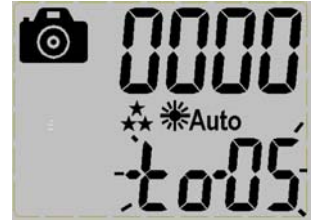

- Press the MODE button repeatedly until LCD flashes “to-xx” where “xx” represents the minutes e.g. 05
- Press the SET button to increase the interval – when it reaches 60 the value will revert to 0.
- If you want **continuous recording** of either photos or video each time movement is detected, set this interval to 0.
- Press the MODE button to confirm and exit.

22

### 2. Resolution settings:

- Press the MODE button repeatedly until the LCD displays “★★” or “★” flashing. (Use the MODE button to toggle)
- ★★ is high resolution 2.0M.
- ★ is Low resolution 1.3M.



- Press the SET button to confirm and LCD will display “dONE”, and then enter into next setting.

23

### 3. Still image or video capture:

- Press the MODE button repeatedly until LCD shows “📷” or “📷P” or “🗣️” flashing.
  - 📷 is one still image shot per PIR trigger.
  - 📷P is two still image shot per PIR trigger.
  - 🗣️ is 10 seconds video clip per PIR trigger.
- Use MODE to change the setting and press the SET button to confirm. The LCD will display “dONE”

### 4. Floodlight control setting:

- Press the MODE button repeatedly until LCD shows “Auto” or “oFF” flashing.
  - In the **Auto** mode the floodlight is controlled by the camera sensor when light levels drop.
  - In the **oFF** mode the floodlight is controlled by the photo sensor when light levels drop.
- If set to OFF the icon 🌟Auto will disappear from the LCD.

24

- Press the SET button to confirm and LCD will display “**dONE**”, then enter into next setting.

#### 5. Exit MODE setting:

- Press the MODE button repeatedly until the LCD flashes “**ESC**”
- Press the SET button to confirm and the LCD will display “**dONE**”, the SL1001 will start a 60 second countdown ready to operate.

#### 6. Other settings:

- **Floodlight on timer control:** Turn the time control knob to “**+**” side to increase the floodlight on time, turn the control knob to “**-**” side to reduce the floodlight on time. Save power by setting this low.
- **Lux control:** Turn the Lux control knob to “**SUN**” side; the floodlight will turn on in brighter conditions.
- Turn the Lux control knob to “**Moon**” side; then floodlight will not turn on until conditions are darker.

25



#### • Deleting captured images or video:

We recommend you delete data from your SD card using your PC or card reader.

- To delete using your SL1001, press the SET and MODE button together to enter test mode and the LCD will display the word “**tEst**”.
- Press the MODE button repeatedly until “ **ONE**” or “ **ALL**” is shown.
- Now press the SET button to confirm.
- Press the SET button until LCD shows “**ESC**” and then press the SET again to exit.
- Now press the SET and MODE button together to exit test mode and start a 60 second arming count-down.

26

### G. USB Driver and Ulead Photo Explorer installation

**Attention** - Your SL1001 is supplied with the driver on a CD-ROM which is designed for PC's only. Playing this CD-ROM on a stereo or CD player may cause damage to it.

- Before installing the software ensure the USB cable is unplugged from your PC.
- Insert the CDROM in CD driver of your PC.
- The auto-run program should start.
- Follow the instructions to first install the driver, then install the Ulead Photo Explorer software. Now restart windows.
- If the installation software doesn't run automatically, please click “Start” and choose “Run”, and then browse the CD drive and select autorun.exe to start the installation.
- To install the Ulead Photo Explorer software you will need to enter the serial number which is printed on the CD cover supplied.

27

### H. Viewing images via PC or digital camera

- You can connect directly to the memory or SD card of your SL1001 using the USB lead provided. Alternatively you can use a card reader or a digital camera to read the SD card.
- When connected the SD card will show as a removable hard drive and you can use Windows Explorer, the Ulead Photo Explorer software or another viewing application to navigate to \DCIM\100 MEDIA and see your SL1001 captured images or video.
- You can copy images to your PC or delete them from your SL1001 memory or SD card using your PC directly.

#### 1. Viewing images via your SL1001 directly on your PC

- Connect the USB lead to your SL1001 and then to a USB port on your PC.
- Your SL1001 will automatically change to USB mode and the display will show “**USB**”
- The internal memory or SD card will now show on your computer as a removable drive.

28

## 2. Viewing images through a card reader or digital camera

- Open the cover of the SD slot on the SL1001,
- Push in the SD memory card and it will spring out, carefully remove it from your SL1001.
- Put the SD card in to a card reader or digital camera. With either device connected to your PC in the usual way the SD card will appear as a removable hard drive.

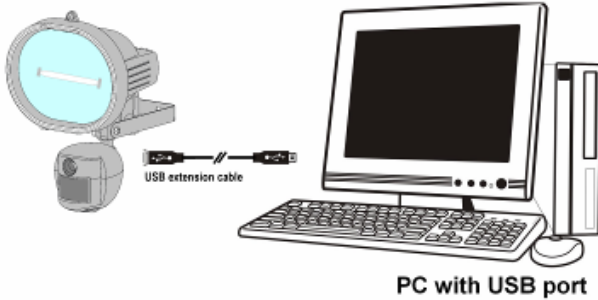

29

- If you have difficulties you can test your camera by selecting the Scanners and Cameras folder from within your PC control panel. If correctly installed an icon will show for your camera – double click this and select the option to test the camera.
- If no icon is present disconnect the USB lead and repeat the process to install the driver before reconnecting the USB lead from the SL1001.
- To use your SL1001 as a web cam you can now open the Ulead Photo Explorer software or use another application to view live images.
- From within the Ulead Photo Explorer select Video, Capture Video option to view live video from your SL1001.

31

## I. Web Cam Mode

- Your SL1001 can also be used as a web cam
- To enable web cam mode the power to the SL1001 must be turned off and the camera driver already installed on your PC. With the power off neither the light or the integrated digital video recorder will function. Digital recording can be performed using your PC and our recommended software.
- Turn off the power to your SL1001.
- Connect a USB cable to your SL1001 and then your PC.
- Your PC will beep to indicate a new device has been found.
- Your SL1001 will be powered by the USB port of your PC and the display will show “ **PC-C**”
- Note: If you are using a long USB lead or your computer's USB port is unable to provide enough power for the SL1001 you may experience difficulties such as no operation, black and white or poor picture quality. Please try a different USB port or shorter cable.

30

## J. Technical Specifications

### 1. System Requirements and Compatibility

- Windows 98/98se/2000/Me/XP.
- Pentium III 450MHz or equivalent processor.
- 128MB SDRAM or above.
- VGA Video Card with 32MB RAM minimum
- Colour 16 bit or higher.
- An available CDROM driver and an available USB Port.
- 600 MB free hard disc space.
- ❖ ***If you have any questions regarding your PC specifications please refer to your PC manufacturer.***

32



## 2. Features and specification

- PIR detection angle 52 Deg and detection range up to 9M.
- Colour CMOS Image Sensor 1.3M pixels.
- Max Resolution: 2.0M pixels, 1600 x 1200 pixels by hardware interpolation
- 3 Capture options: Still image, 2P burst capturing, 10 seconds video recording
- Image performance for video stream:  
10fps at 320 x 240 pixels
- Built in 16MB SDRAM for image buffer and image storage
- Built in status LCD display
- Built in SD card slot for SD memory card
- Built in TEST indication to show the PIR coverage area
- SD Card slot for additional storage, max memory size up to 1GB
- Automatic exposure control, white balance and sharpness
- Auto Date & Time stamp
- High precision 4 piece glass lens with IR coating

33

- Focusing: 1.5m (minimum) to Infinity
- Effective viewing angle: 48 deg
- Built in USB plug for PC access
- Interface type: USB 1.1
- Image format: JPG, Motion JPEG
- Powered by AC 110V or 220V (subject to requirement).
- Floodlight tube is 500W, type R7S
- Auto light sensor.
- Lux control
- Floodlight turn on time control
- Product measurements: W185 x H265 x T130mm. Weight 1.2Kg.
- Operating Environment: 14 to 104 deg F (-10 to 40 deg C). 20-85% relative humidity, non-condensation.

34

## K. General Information and safety

### Storing conditions

- Storage conditions: -20°C to 55°C, 20-85% R.H., non-condensing

### Special care instructions!!

- *The SL1001 is designed only to be weather resistant. Never attempt to immerse the unit in water or any other liquid. This will damage the unit and void the warranty.*
- *Use a soft lens cloth for cleaning lens. Avoid touching lens with fingers.*
- *Remove dirt or stains with a soft cloth dampened with water or mild detergent. Keep the SL1001 in a dry and cool dust-free environment or container when it is NOT used.*
- *Do not open the SL1001 for unauthorized service. This could cause serious damage to the unit and will void your warranty.*
- *This SL1001 is a precision electronic device. Do not attempt to service this camera yourself, as opening or removing covers may expose you to dangerous voltage*

35

*points or other risks.*

- *Do not touch the floodlight when the power is on, it is extremely hot.*



### Changes to building regulations

As of January 1st 2005, changes to the Building regulations affected domestic electrical installations in England and Wales.

You don't need to be a qualified electrician to make changes to your home's electrical system, but the work must be done in accordance with the standards in the Regulations.

36

## L. FCC Information

This device complies with Part 15 of the FCC Rules. Operation is subject to the following two conditions: (1) This device may not cause harmful interference, and (2) This device must accept any interference received, including interference that may cause undesired operation.

Warning: Changes or modification to this unit not expressly approved by the party responsible for compliance could void the user's authority to operate the equipment.

NOTE: This equipment has been tested and found to comply with the limited for Class B digital device, pursuant to Part 15 of the FCC Rules. Their limits are designed to provide reasonable protection against harmful interference in a residential installation. This equipment generates, uses and can radiate radio frequency energy and, if not installed and used in accordance with the

instructions, may cause harmful interference to radio communications.

However, there is no guarantee that interference will not occur in a particular installation. If the equipment does cause harmful interference to radio or television reception, which can be determined by turning the equipment off and on, the user is encouraged to try to correct the interference by one or more of the following measures:

Reorient or relocate the receiving antenna.

Increase the separation between the equipment and receiver.

Connect the equipment into an outlet on a circuit different from that to which the receiver is connected.

Consult the dealer or an experienced radio/TV technician for help.

SL1001\_R3 Print in China.